

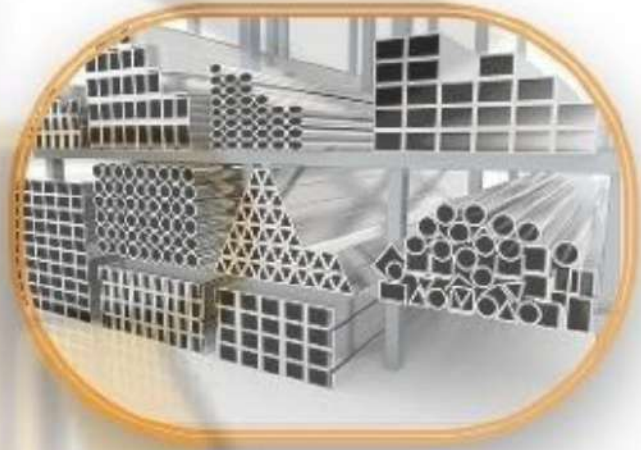

R.C. ALUMINIUM

AN ISO 9001-2015 CERTIFIED COMPANY





INDEX

Sr.No.	Contents	Page No.
1	RECTANGULAR TUBE	01
2	SQUARE TUBE	02
3	PARTITION AND DOOR SECTION	02 - 07
4	"Z" SECTION AND GLASS SECTION	08 - 09
5	CURTAIN WALL SECTION	10 - 11
6	18MM SERIES	12 - 16
7	SINTEX SECTION	17
8	18X60 AND 18X50	18
9	25MM SERIES	19 - 20
10	20MM SERIES	21 - 23
11	LOUVERS,G SECTION AND FLAT BAR	24
12	ANGLES AND CHANNLES	25 - 27
13	3X1 MOLDING	28
14	27MM DOMAL	29



R.C. ALUMINIUM

Shop
Jhulelal Chowk, Nahar Para,
Station Road, Raipur (C.G.)
Pin code :492001

Factory
Engineering Park
Heavy Industrial Area,
Hathkhoj, Bilal. District-Durg
Pin code : 490026

8889999667
8889999646
8889999668

rcaluminium@gmail.com

www.rcaluminium.in

RECTANGULAR TUBE



R.C. ALUMINIUM

AN ISO 9001-2015 CERTIFIED COMPANY

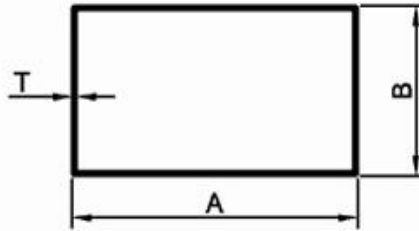

SEC. NO.	C/L	A	B	T	WR. RANGE
R.C-1001	12'	36	24	0.5	0.700 - 0.900
R.C-1002	12'	36	24	0.8	1.000 - 1.100
R.C-1003	12'	36	24	1.2	1.500 - 1.700
R.C-1004	12'	48	24	0.7	0.900 - 1.000
R.C-1005	12'	48	24	0.9	1.100 - 1.200
R.C-1006	12'	50	25	0.8	0.800 - 1.000
R.C-1007	12'	50	25	1.1	1.600 - 1.800
R.C-1008	12'	50	25	1.5	2.200 - 2.400
R.C-1009	12'	50	25	2.0	2.900 - 3.100
R.C-1010	12'	63	25	0.8	1.200 - 1.400
R.C-1011	12'	63	25	1.0	1.500 - 1.600
R.C-1012	12'	63	25	1.1	1.800 - 2.000
R.C-1013	12'	63	38	1.0	1.800 - 2.000
R.C-1014	12'	63	38	1.2	2.400 - 2.600
R.C-1015	12'	63	38	1.5	2.800 - 3.000
R.C-1016	12'	63	38	2.0	3.800 - 4.000
R.C-1017	12'	75	12	1.4	2.400 - 2.600
R.C-1018	12'	75	18	1.4	2.400 - 2.600
R.C-1019	12'	75	25	1.0	1.800 - 2.000
R.C-1020	12'	75	25	1.2	2.400 - 2.600
R.C-1021	12'	75	25	1.5	2.800 - 3.000
R.C-1022	12'	75	38	1.4	3.000 - 3.200
R.C-1023	12'	100	12	1.4	2.900 - 3.100
R.C-1024	12'	100	18	1.4	3.100 - 3.300
R.C-1025	12'	100	25	1.0	2.600 - 2.800
R.C-1026	12'	101	44	1.4	3.700 - 3.900
R.C-1027	12'	101	44	2.0	5.600 - 5.800
R.C-1028	12'	101	44	3.0	8.500 - 8.700

SQUARE TUBE



R.C. ALUMINIUM
AN ISO 9001-2015 CERTIFIED COMPANY

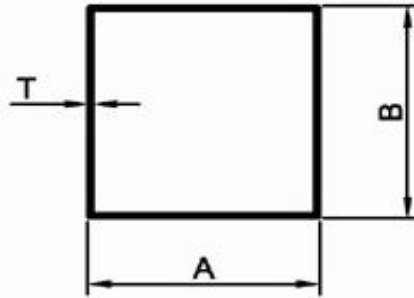

SEC. NO.	C/L	A	B	T	WT. RANGE
R.C-2001	12'	19	19	1.5	1.100 - 1.300
R.C-2002	12'	24	24	0.60	0.600 - 0.800
R.C-2003	12'	24	24	1.20	1.100 - 1.200
R.C-2004	12'	38	38	1.00	1.300 - 1.500
R.C-2005	12'	38	38	1.20	1.500 - 1.700
R.C-2006	12'	38	38	1.50	2.200 - 2.400
R.C-2007	12'	38	38	2.00	2.800 - 3.000
R.C-2008	12'	38	38	3.00	4.400 - 4.600
R.C-2009	12'	50	50	0.95	1.800 - 2.00
R.C-2010	12'	50	50	1.20	2.400 - 2.600
R.C-2011	12'	50	50	1.50	2.800 - 3.000
R.C-2012	12'	50	50	2.70	5.500 - 5.700
R.C-2013	12'	50	50	3.00	5.800 - 6.000

SINGLE PARTITION



R.C. ALUMINIUM
AN ISO 9001-2015 CERTIFIED COMPANY

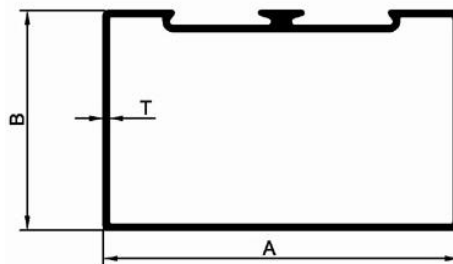

SEC. NO.	C/L	A	B	T	WT. RANGE
R.C- 3001	12'	63	38	0.9	1.700 - 1.900
R.C- 3002	12'	63	38	1.0	2.100 - 2.200
R.C- 3003	12'	63	38	1.2	2.400 - 2.600
R.C- 3004	12'	63	38	1.5	2.800 - 3.000
R.C- 3005	12'	101	44	1.2	3.800 - 4.000
R.C- 3006	12'	101	44	1.5	4.600 - 4.800
R.C- 3007	12'	101	44	2.0	5.700 - 5.900
R.C- 3008	12'	101	44	3.0	8.500 - 8.700

DOUBLE PARTITION

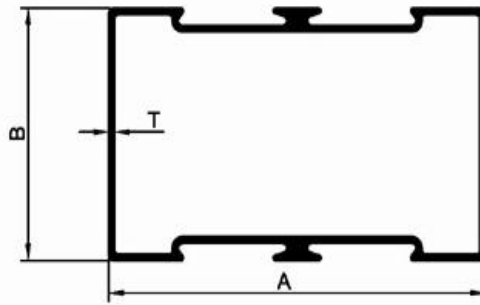

SEC. NO.	C/L	A	B	T	WT. RANGE
R.C- 4001	12'	63	38	0.9	1.800 - 2.000
R.C- 4002	12'	63	38	1.0	2.200 - 2.300
R.C- 4003	12'	63	38	1.2	2.400 - 2.600
R.C- 4004	12'	63	38	1.5	2.800 - 3.000
R.C- 4005	12'	101	44	1.2	3.800 - 4.000
R.C- 4006	12'	101	44	1.5	4.600 - 4.800
R.C- 4007	12'	101	44	2.0	5.700 - 5.900
R.C- 4008	12'	101	44	3.0	8.600 - 8.800

LEG PARTITION (PATAM -GUNDI)

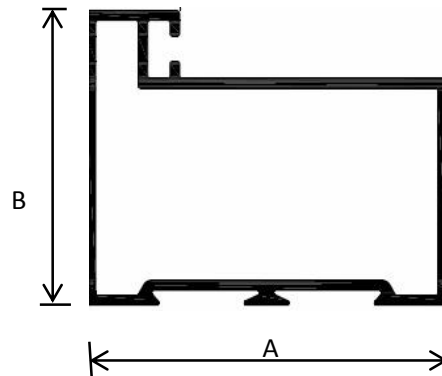

SEC. NO.	C/L	A	B	T	WT. RANGE
R.C-5001	12'	63	38	1	2.800 - 3.000

63X63 CORNER PARTITION

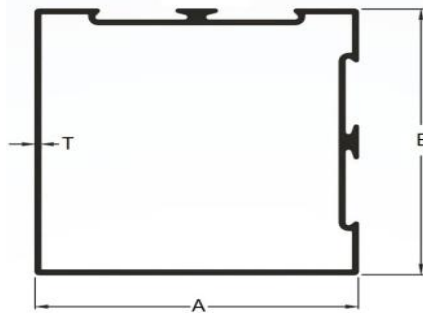

SEC. NO.	C/L	A	B	T	WT. RANGE
R.C-6001	12'	63	63	0.8	2.000 - 2.200

DOOR MIDDLE SINGLE

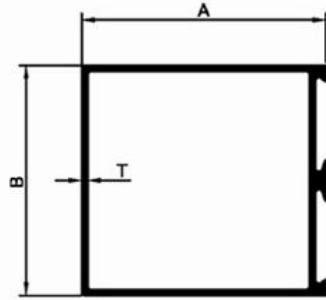

SEC. NO.	C/L	A	B	T	WT. RANGE
R.C-7001	12'	47	44	1	1.800 - 2.000
R.C-7002	12'	47	44	1.2	2.200 - 2.400
R.C-7003	12'	47	44	1.5	2.900 - 3.100
R.C-7004	12'	85	44	1.5	3.800 - 4.000
R.C-7005	12'	85	44	2	5.500 - 5.700

DOOR MIDDLE DOUBLE

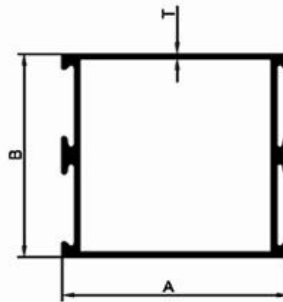

SEC. NO	C/L	A	B	T	WT. RANGE
R.C-8001	12'	47.5	44.5	1	1.800 - 2.000
R.C-8002	12'	47.5	44.5	1.2	2.200 - 2.400
R.C-8004	12'	85	44	1.5	3.800 - 4.000
R.C-8005	12'	85	44	2	5.500 - 5.700

DOOR VERTICAL

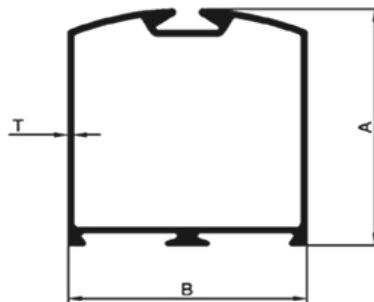

SEC. NO.	C/L	A	B	T	WT. RANGE
R.C-9001	12'	47.5	44.5	1	2.300 - 2.500
R.C-9002	12'	47.5	44.5	2	2.800 - 3.000
R.C-9003	12'	85	44	1.2	4.000 - 4.200
R.C-9004	12'	85	44	3	7.300 - 7.500

DOOR TOP



R.C. ALUMINIUM

AN ISO 9001-2015 CERTIFIED COMPANY

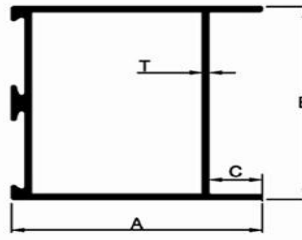

SEC. NO.	C/L	A	B	C	T	WT. RANGE
R.C-10001	12'	47	44	9.5	1	2.200 - 2.400
R.C-10002	12'	47	44	9.5	1.5	3.100 - 3.300
R.C-10003	12'	47	44	9.5	2	3.800 - 4.000

DOOR TOP SINGLE LEG



R.C. ALUMINIUM

AN ISO 9001-2015 CERTIFIED COMPANY

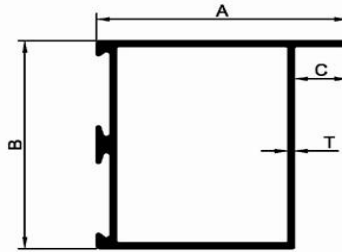

SEC. NO.	C/L	A	B	C	T	WT. RANGE
R.C-11001	12'	47	44	9.5	1.25	2.200 - 2.400
R.C-11002	12'	47	44	9.5	2	3.800 - 4.000

DOOR BOTTOM



R.C. ALUMINIUM

AN ISO 9001-2015 CERTIFIED COMPANY

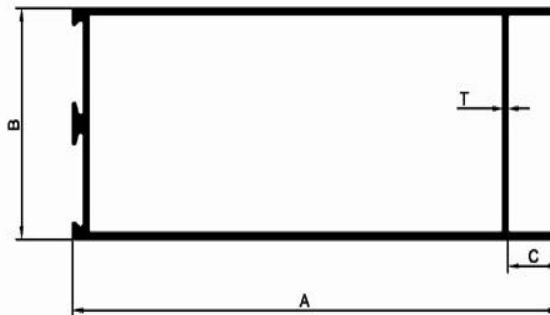

SEC. NO.	C/L	A	B	C	T	WT. RANGE
R.C-12001	12'	114	44	10.15	1.2	3.800 - 4.000
R.C-12002	12'	114	44	10.15	1.5	4.800 - 5.000
R.C-12003	12'	85	44	9.5	1.5	3.800 - 4.000
R.C-12004	12'	85	44	9.5	2.9	7.200 - 7.400

SAMOSA SECTION

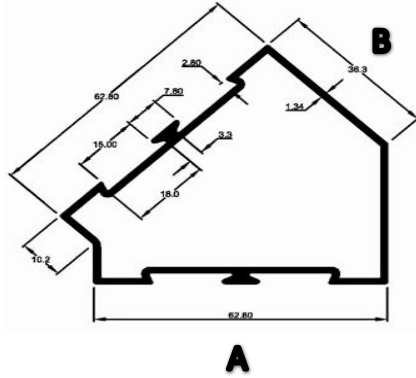

SEC. NO.	C/L	A	B	T	WT. RANGE
R.C-13001	12'	62.8	36.6	0.85	2.200 - 2.400

38X25 L TUBE

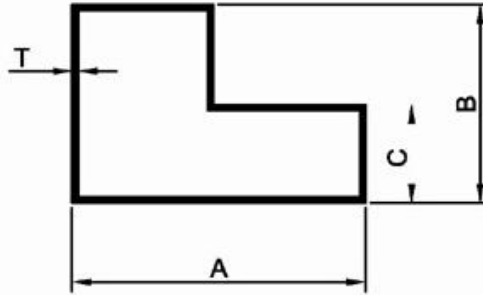

SEC. NO.	C/L	A	B	C	T	WT. RANGE
R.C-14001	12'	38	24	12	0.8	0.900 - 1.000
R.C-14002	12'	38	24	12	1	1.000 - 1.200

50X25 L TUBE

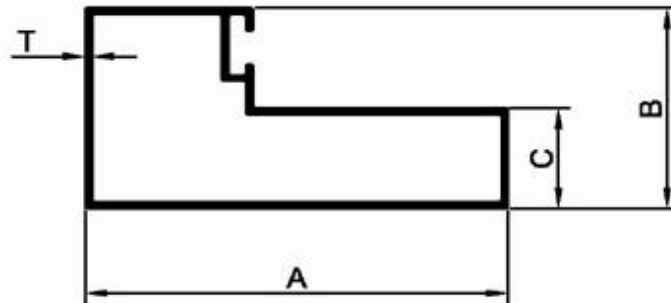

SEC. NO.	C/L	A	B	C	T	WT. RANGE
R.C-15001	12'	48	24	12	0.75	1.200 - 1.300

50X32 L TUBE

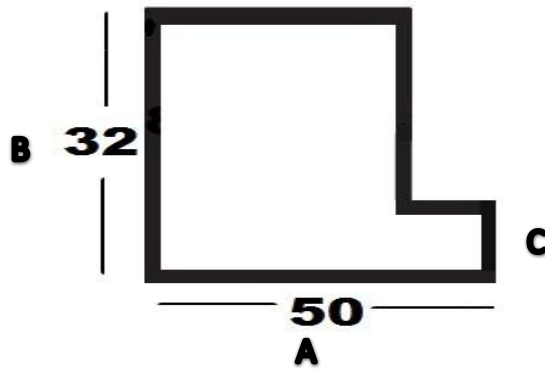

SEC. NO.	C/L	A	B	C	T	WT. RANGE
R.C-16001	12'	50	32	12	0.8	1.300 - 1.500

63x38 WOODEN CHOUKHAT

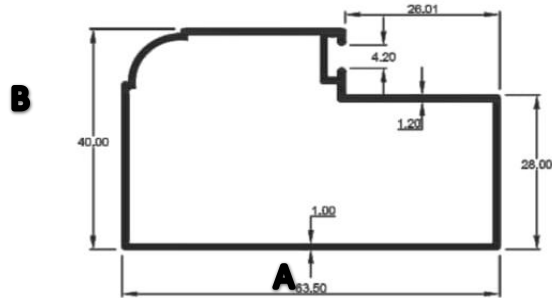

SEC.NO	C/L	A	B	T	WT. RANGE
R.C-17001	12'	63	38	0.8	1.600 - 1.800
R.C-17002	12'	63	38	0.9	1.800 - 2.000
R.C-17003	12'	63	38	1.1	2.000 - 2.200
R.C-17004	12'	63	38	1.2	2.300 - 2.500
R.C-17005	12'	108	53	2.2	6.800 - 7.000

63X38 WOODEN CHAOUKHAT (PLAIN)

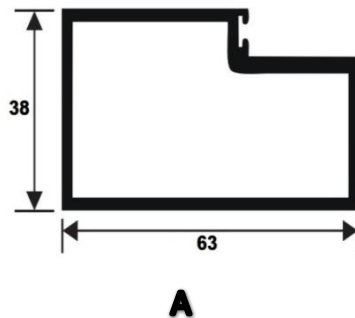

SEC. NO.	C/L	A	B	T	WT. RANGE
R.C-18001	12'	63	38	0.9	1.800 - 2.000

"Z" FRAME

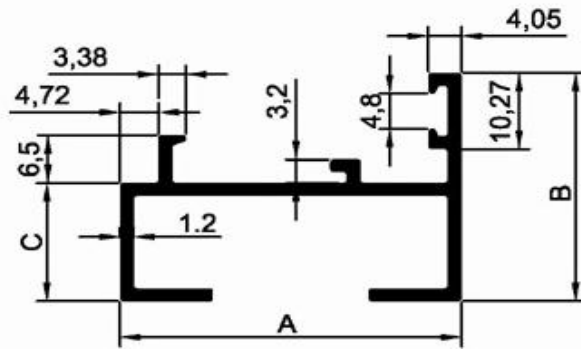

SEC. NO.	C/L	A	B	C	T	WT. RANGE
R.C-19001	12'	41.9	30.9	16	1.3	1.600 - 1.800

"Z" OUTER [Outer H]

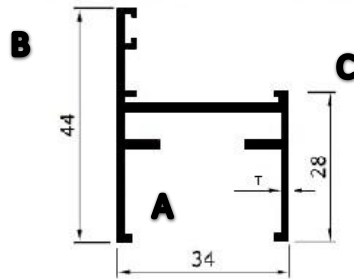

SEC. NO.	C/L	A	B	C	T	WT. RANGE
R.C-20001	12'	34	44	28	0.95	1.100 - 1.300
R.C-20002	12'	34	44	28	1.2	1.600 - 1.800

"Z" MULLION

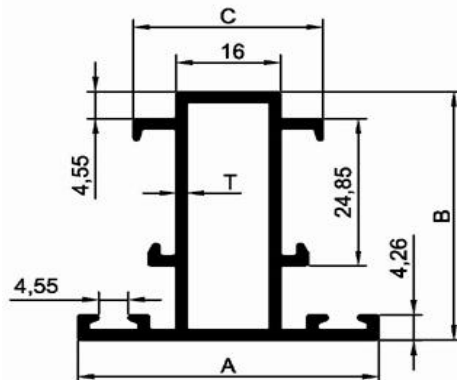

SEC. NO.	C/L	A	B	C	T	WT. RANGE
R.C-21001	12'	46	42	29	1.2	2.200 - 2.400

"Z" HOLLOW

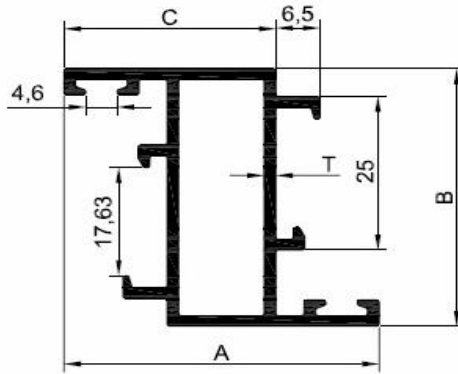

SEC. NO.	C/L	A	B	C	T	WT. RANGE
R.C-22001	12'	46	42	31	1.15	2.000 - 2.200

"Z" CLIP

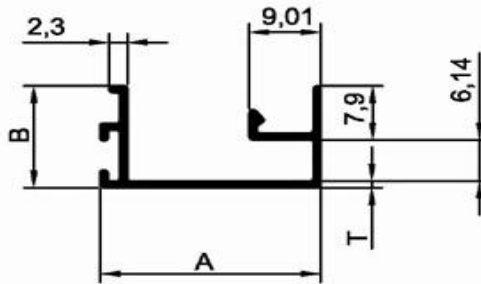

SEC. NO.	C/L	A	B	T	WT. RANGE
R.C-23001	12'	27.8	15	0.96	0.600 - 0.700

GLASS SECTION 12MM SOLID

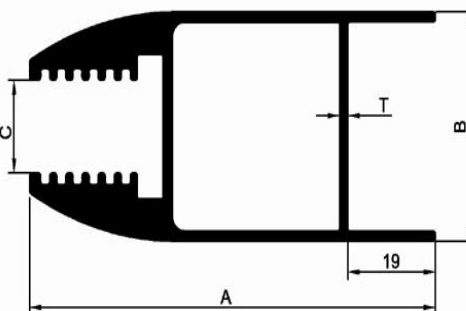

SEC. NO.	C/L	A	B	C	T	WT. RANGE
R.C-24001	12'	88	40	16	-	8.000 - 8.200

CURTAIN WALL

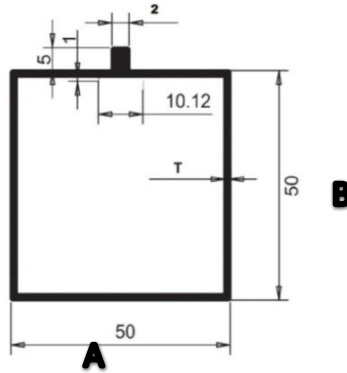

R.C. ALUMINIUM
AN ISO 9001-2015 CERTIFIED COMPANY



SEC. NO.	C/L	A	B	C	T	WT. RANGE
R.C-25001	12'	50	50	6	1.2	3.200 - 3.400
R.C-25002	12'	63	57	6	1.6	3.800 - 4.000
R.C-25003	12'	80	50	6	1.5	3.800 - 4.000

80X57 CURTAIN WALL (LONG NOSE)

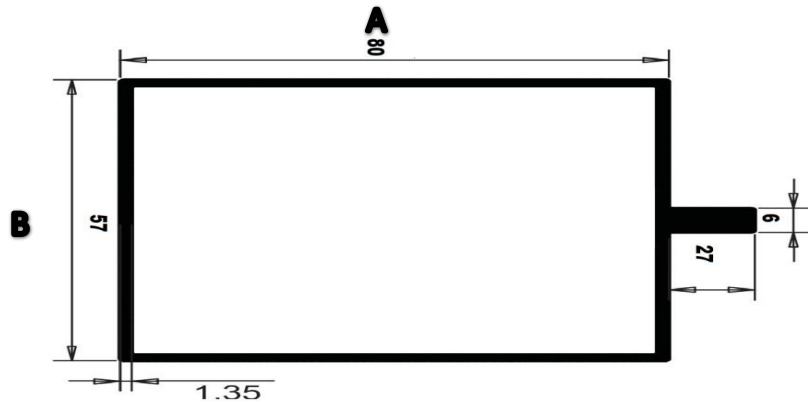

R.C. ALUMINIUM
AN ISO 9001-2015 CERTIFIED COMPANY



SEC. NO.	C/L	A	B	C	T	WT. RANGE
R.C-26001	12'	80	57	6	2	6.600 - 6.800

C/W - BALUNE ON KODNAO

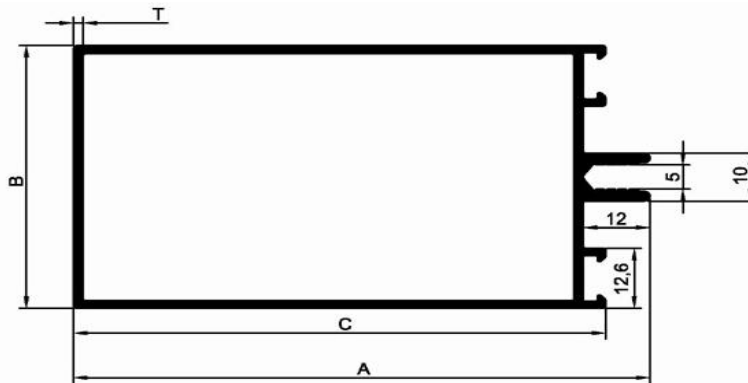
R.C. ALUMINIUM
AN ISO 9001-2015 CERTIFIED COMPANY



SEC. NO.	C/L	A	B	C	T	WT. RANGE
R.C-27001	12'	104	55	96	1.7	7.100 - 7.500

COVER PLATE

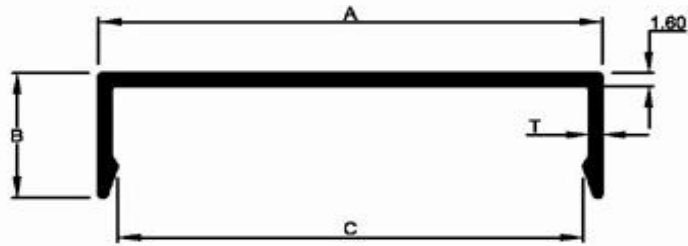

SEC. NO.	C/L	A	B	C	T	WT. RANGE
R.C-28001	12'	55	15	50	1.2	1.000 - 1.200

PRESSURE PLATE

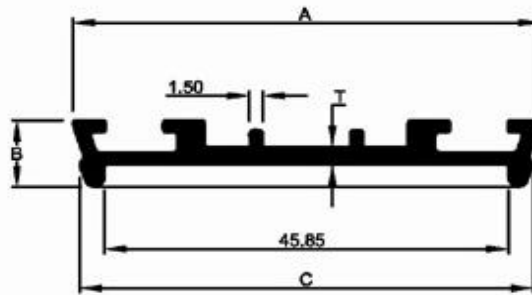

SEC. NO.	C/L	A	B	C	T	WT. RANGE
R.C-29001	12'	53	8	51.35	1.65	1.100 - 1.300

18mm series - 2 TRACK TOP

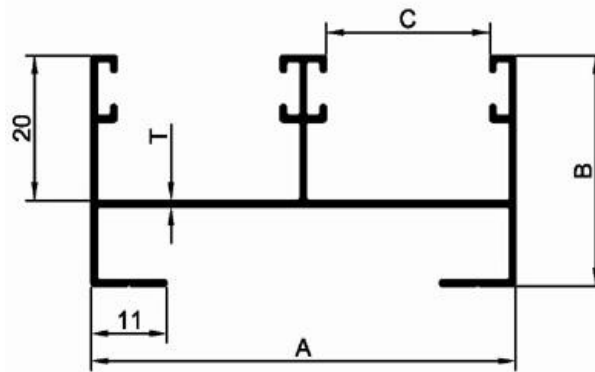

SEC. NO.	C/L	A	B	C	T	WT. RANGE
R.C-30001	12'	61.85	31.75	23.85	0.85	1.400 - 1.600
R.C-30002	12'	61.85	31.75	23.85	1	1.800 - 2.000
R.C-30003	12'	61.85	31.75	23.85	1.2	2.300 - 2.500
R.C-30004	12'	61.85	31.75	23.85	1.5	3.000 - 3.200

18mm series - 2 TRACK BOTTOM

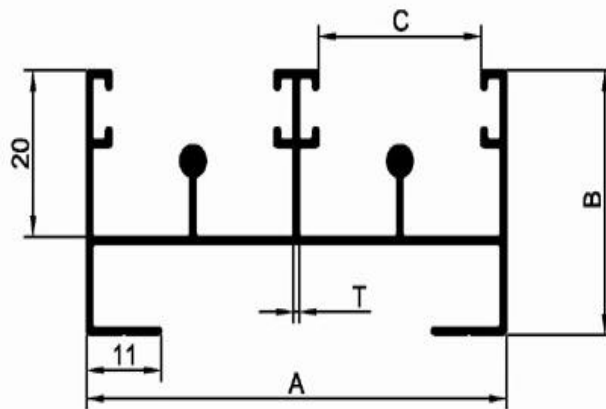

SEC. NO.	C/L	A	B	C	T	WT. RANGE
R.C-31001	12'	61.85	31.75	23.85	0.85	1.600 - 1.800
R.C-31002	12'	61.85	31.75	23.85	1	1.800 - 2.000
R.C-31003	12'	61.85	31.75	23.85	1.2	2.300 - 2.500
R.C-31004	12'	61.85	31.75	23.85	1.5	3.000 - 3.100

18mm series - 3 TRACK TOP

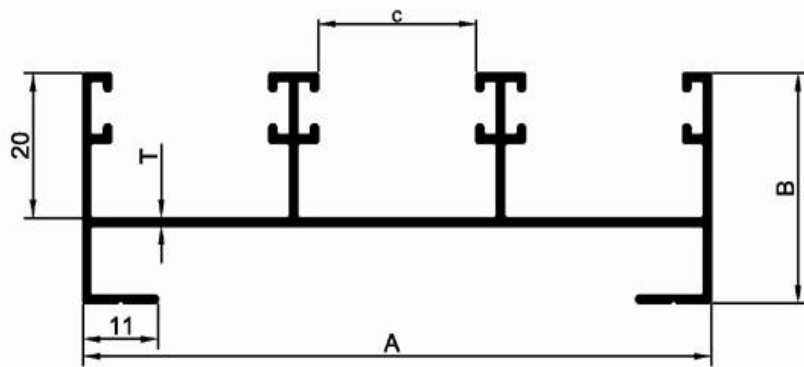

SEC. NO.	C/L	A	B	C	T	WT. RANGE
R.C-32001	12'	92	31.75	23.1	0.75	1.800 - 2.000
R.C-32002	12'	92	31.75	23.1	1	2.200 - 2.400
R.C-32003	12'	92	31.75	23.1	1.2	2.800 - 3.000
R.C-32004	12'	92	31.75	23.1	1.5	3.800 - 4.000

18mm series - 3 TRACK BOTTOM

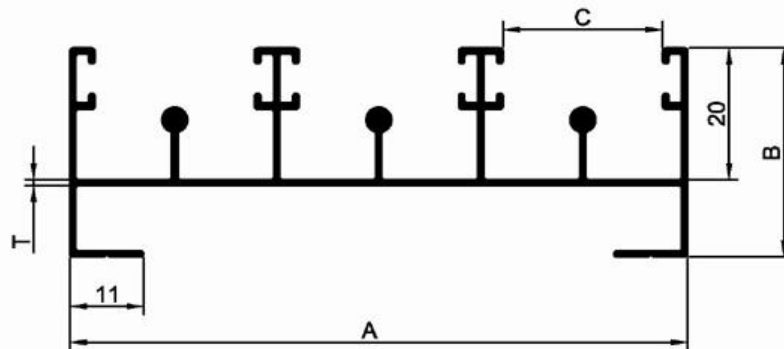

SEC. NO.	C/L	A	B	C	T	WT. RANGE
R.C-33001	12'	92	31.75	23.8	0.8	2.000 - 2.200
R.C-33002	12'	92	31.75	23.8	0.95	2.200 - 2.400
R.C-33003	12'	92	31.75	23.8	1.2	2.800 - 3.000
R.C-33004	12'	92	31.75	23.8	1.5	3.800 - 4.000

18mm series - 4 TRACK TOP

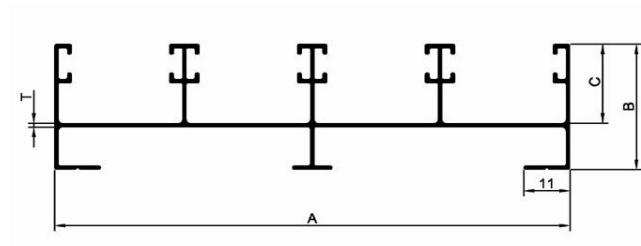

SEC. NO.	C/L	A	B	C	T	WT. RANGE
R.C-34001	12'	122	31.75	20	1.5	5.000 - 5.200

18mm series - 4 TRACK BOTTOM

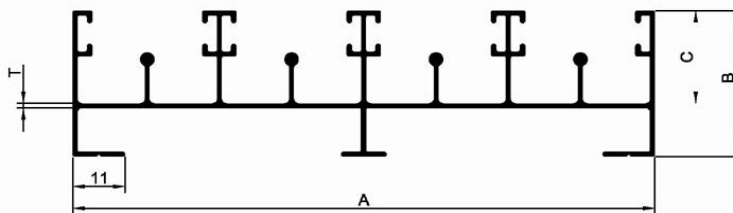

SEC. NO.	C/L	A	B	C	T	WT. RANGE
R.C-35001	12'	122	31.75	20	1.35	5.000 - 5.200

18mm SERIES - HANDLE

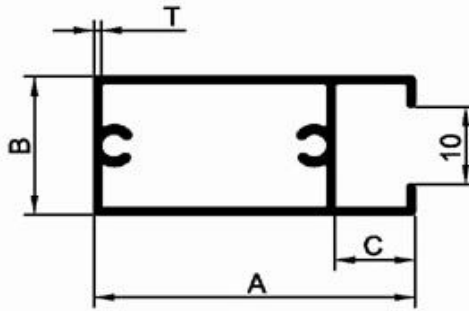

SEC. NO.	C/L	A	B	C	T	WT. RANGE
R.C-36001	12'	40	18	10	0.65	0.900 - 1.000
R.C-36002	12'	40	18	10	1.00	1.100 - 1.200
R.C-36003	12'	40	18	10	1.20	1.400 - 1.600
R.C-36004	12'	40	18	10	1.50	1.800 - 2.000
R.C-36005	12'	40	18	10	1.80	2.000 - 2.300

18mm SERIES - MIDDLE

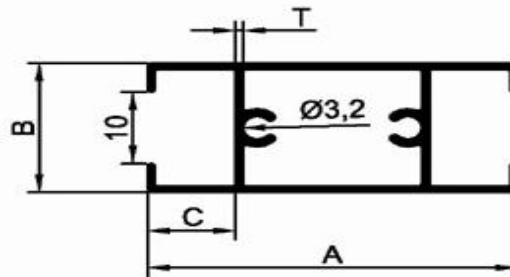

SEC. NO.	C/L	A	B	C	T	WT. RANGE
R.C-37001	12'	40	18	10	0.65	0.900 - 1.000
R.C-37002	12'	40	18	10	1.00	1.200 - 1.400
R.C-37003	12'	40	18	10	1.20	1.400 - 1.600
R.C-37004	12'	40	18	10	1.50	2.000 - 2.200

18mm SERIES - TOP BOTTOM

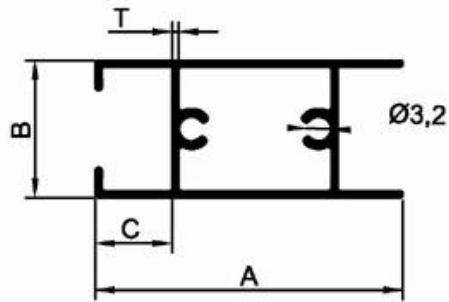

SEC. NO.	C/L	A	B	C	T	WT. RANGE
R.C-38001	12'	40	18	10	0.65	0.900 - 1.000
R.C-38002	12'	40	18	10	1	1.200 - 1.400
R.C-38003	12'	40	18	10	1.2	1.400 - 1.600
R.C-38004	12'	40	18	10	1.5	1.800 - 2.000

18mm SERIES - INTERLOCK

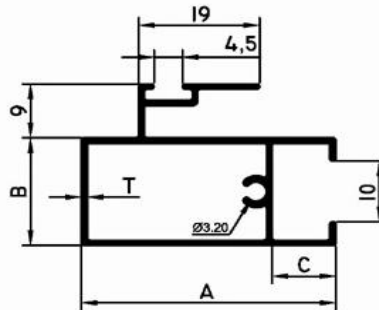

SEC. NO.	C/L	A	B	C	T	WT. RANGE
R.C-39001	12'	40	18	10	0.7	1.000 - 1.100
R.C-39002	12'	40	18	10	0.8	1.300 - 1.500
R.C-39003	12'	40	18	10	1.1	1.500 - 1.700
R.C-39004	12'	40	18	10	1.2	1.800 - 2.000
R.C-39005	12'	40	18	10	1.5	2.200 - 2.400

SINTAX "A" (WITHOUT GROVE)



R.C. ALUMINIUM
AN ISO 9001-2015 CERTIFIED COMPANY

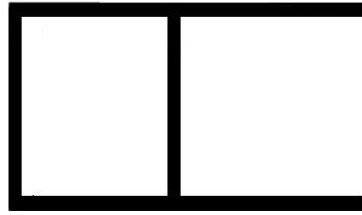

SEC. NO.	C/L	A	B	C	T	WT. RANGE
R.C-40001	12'	40	23.6	16.3	0.7	0.700 - 0.800

SINTAX "A" (with groove)



R.C. ALUMINIUM
AN ISO 9001-2015 CERTIFIED COMPANY

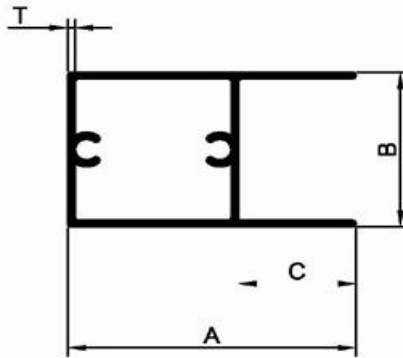

SEC. NO.	C/L	A	B	C	T	WT. RANGE
R.C-41001	12'	40	23.6	16.3	0.7	0.700 - 0.900
R.C-41002	12'	40	23.6	16.3	1	1.100 - 1.300

SINTAX "H"



R.C. ALUMINIUM
AN ISO 9001-2015 CERTIFIED COMPANY

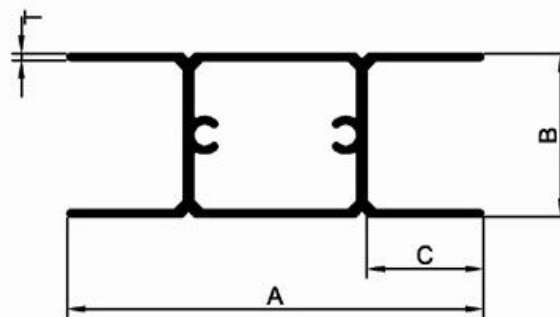

SEC. NO.	C/L	A	B	C	T	WT. RANGE
R.C-42001	12'	60	23	16.5	0.75	1.200 - 1.400

60X18 SHUTTER

RC-43001 HANDLE

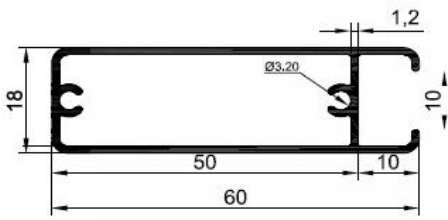

RC-43002 INTER LOCK

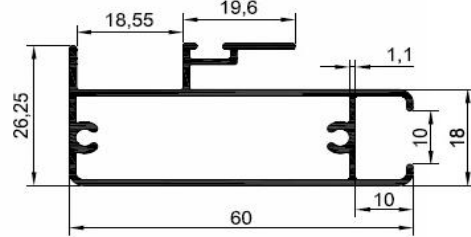

WEIGHT - 1.200 - 1.400 KG/12'

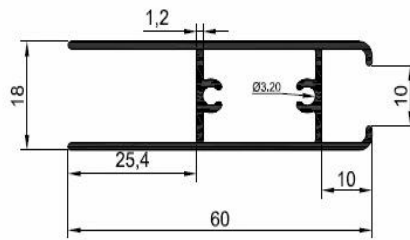

WEIGHT - 2.000 KG/12'

18X50 HANDLE



R.C-44001 HANDLE

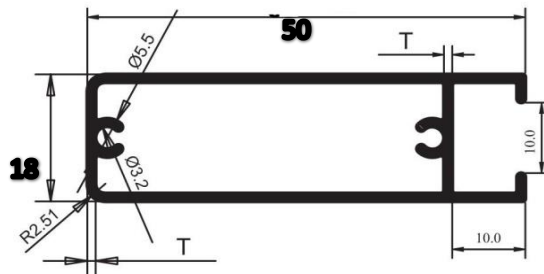

WEIGHT - 1.300 - 1.500 KG/12'

18X50 INTERLOCK



R.C-45001 INTERLOCK

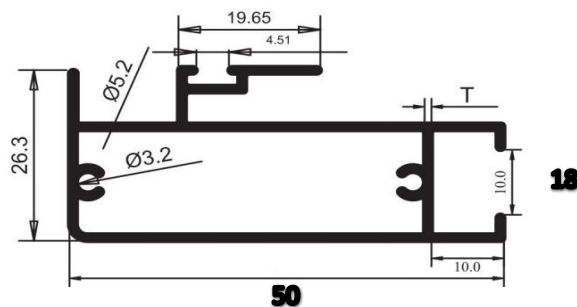

WEIGHT - 1.300 - 1.500 KG/12'

25mm SERIES - 3 TRACK TOP

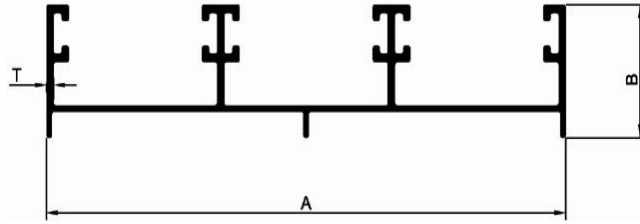

SEC. NO.	C/L	A	B	T	WT. RANGE
R.C-46001	12'	116	25	1.8	4.500 - 4.700

25mm SERIES - 3 TRACK BOTTOM

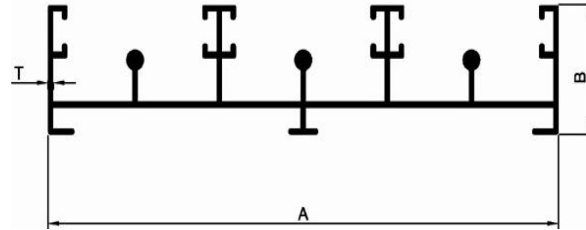

SEC. NO.	C/L	A	B	T	WT. RANGE
R.C-47001	12'	116	25	1.9	4.800 - 5.000

25mm SERIES - HANDLE

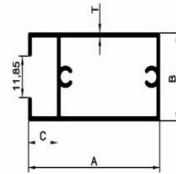

SEC. NO.	C/L	A	B	C	T	WT. RANGE
R.C-48001	12'	50	25	11	0.9	1.300 - 1.500
R.C-48002	12'	50	25	11	1.2	1.500 - 1.700
R.C-48003	12'	50	25	11	1.4	2.200 - 2.400
R.C-48004	12'	75	25	11	0.8	1.900 - 2.100

25mm SERIES - INTER LOCK

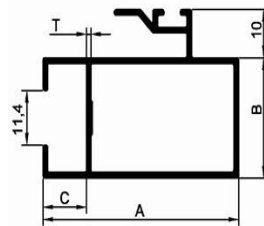

SEC. NO.	C/L	A	B	C	T	WT. RANGE
R.C-49001	12'	50	25	11	1.2	2.300 - 2.400

25mm SERIES - TOP BOTTOM

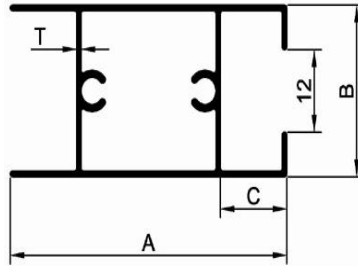

SEC. NO.	C/L	A	B	C	T	WT. RANGE
R.C-50001	12'	50	25	12.5	0.85	1.300 - 1.500
R.C-50002	12'	50	25	12.5	1.4	2.200 - 2.400

25mm SERIES - MATTING

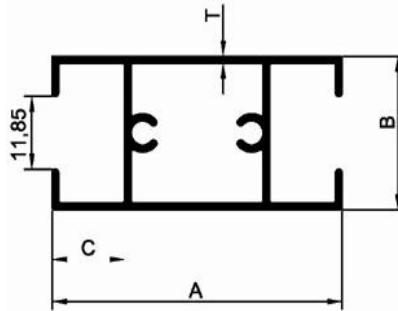

SEC. NO.	C/L	A	B	C	T	WT. RANGE
R.C-51001	12'	50	25	12.5	0.8	1.300 - 1.500
R.C-51002	12'	50	25	12.5	0.9	1.600 - 1.800
R.C-51003	12'	75	25	12.5	0.95	2.200 - 2.400

25MM SERIES - BEARING BOTTOM

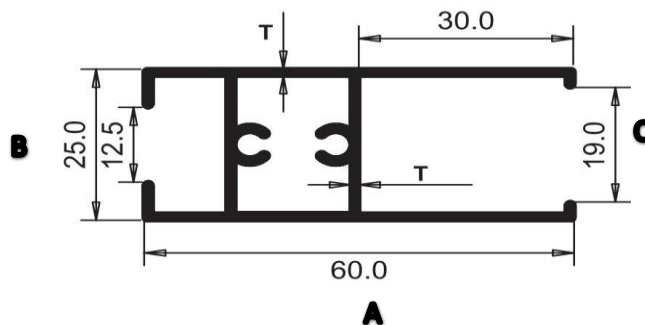

SEC. NO.	C/L	A	B	C	T	WT. RANGE
R.C-52001	12'	60	25	19	1.3	2.500 - 2.600

20MM SERIES - 2 TRACK TOP

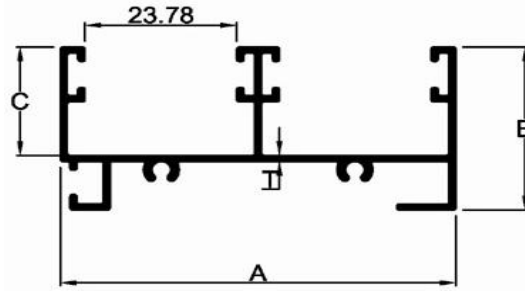

SEC. NO.	C/L	A	B	C	T	WT. RANGE
R.C-53001	12'	62	29.5	19.6	0.75	1.500 - 1.700
R.C-53002	12'	62	29.5	19.6	1	2.000 - 2.200
R.C-53003	12'	62	29.5	19.6	1.5	2.800 - 3.000
R.C-53004	12'	62	29.5	19.6	2	3.700 - 3.900

20MM SERIES- 2 TRACK BOTTOM

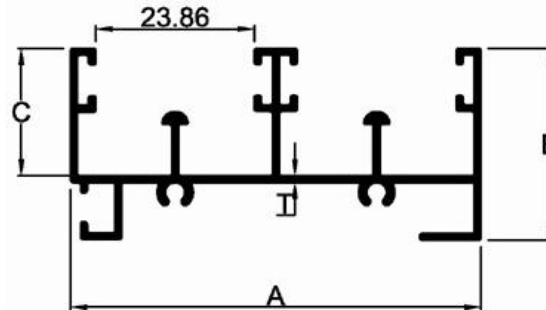

SEC. NO.	C/L	A	B	C	T	WT. RANGE
R.C-54001	12'	62	29.5	19.6	0.7	1.600 - 1.800
R.C-54002	12'	62	29.5	19.6	1	2.000 - 2.200
R.C-54003	12'	62	29.5	19.6	1.5	3.200 - 3.400
R.C-54004	12'	62	29.5	19.6	2	4.100 - 4.300

20MM SERIES - 3 TRACK TOP

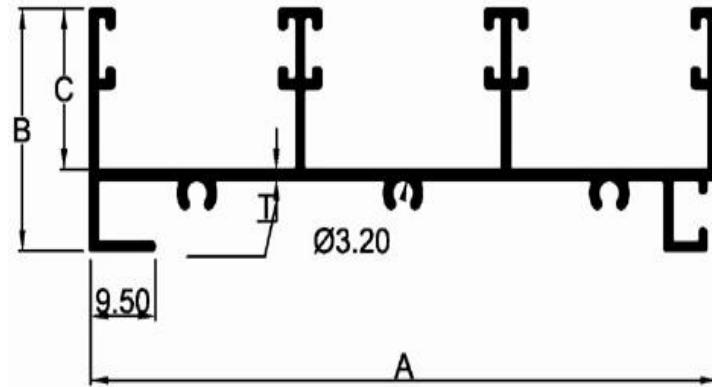

SEC. NO.	C/L	A	B	C	T	WT. RANGE
R.C-55001	12'	92	29.5	19.6	0.85	2.100 - 2.300
R.C-55002	12'	92	29.5	19.6	1.2	2.800 - 3.000
R.C-55003	12'	92	29.5	19.6	1.5	3.800 - 4.000
R.C-55004	12'	92	29.5	19.6	2	5.300 - 5.500

20MM SERIES - 3 TRACK BOTTOM

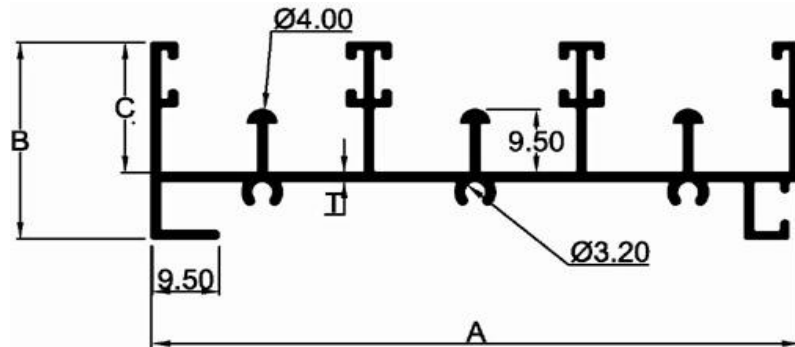

SEC. NO.	C/L	A	B	C	T	WT. RANGE
R.C-56001	12'	92	29.5	19.6	0.9	2.400 - 2.600
R.C-56002	12'	92	29.5	19.6	1.1	2.800 - 3.000
R.C-56003	12'	92	29.5	19.6	1.5	4.400 - 4.600
R.C-56004	12'	92	29.5	19.6	2	5.900 - 6.100

20MM SERIES - HANDLE

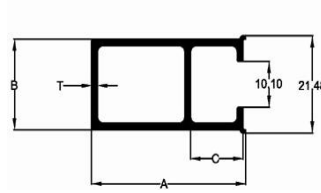

SEC. NO.	C/L	A	B	C	T	WT. RANGE
R.C-57001	12'	39	20	13.2	0.9	1.000 - 1.200
R.C-57002	12'	39	20	13.2	1	1.300 - 1.500
R.C-57003	12'	39	20	13.2	1.2	1.600 - 1.800
R.C-57004	12'	39	20	13.2	1.5	1.800 - 2.000
R.C-57005	12'	39	20	13.2	2	2.200 - 2.400

20MM SERIES - INTERLOCK

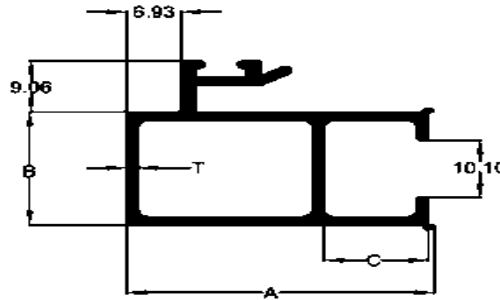

SEC. NO.	C/L	A	B	C	T	WT. RANGE
R.C-58001	12'	39	20	13.2	0.9	1.200 - 1.400
R.C-58002	12'	39	20	13.2	1.2	1.600 - 1.800
R.C-58003	12'	39	20	13.2	1.5	1.900 - 2.100
R.C-58004	12'	39	20	13.2	2	

20MM SERIES - TOP BOTTOM

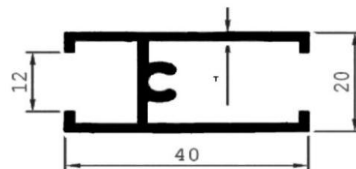

SEC. NO.	C/L	A	B	T	WT. RANGE
R.C-59001	12'	41	20	0.75	0.900 - 1.100
R.C-59002	12'	41	20	1	1.200 - 1.400
R.C-59003	12'	41	20	1.3	1.600 - 1.800
R.C-59004	12'	41	20	1.5	1.800 - 2.000
R.C-59005	12'	41	20	2	2.200 - 2.400

LOUVER SECTION



R.C-60001

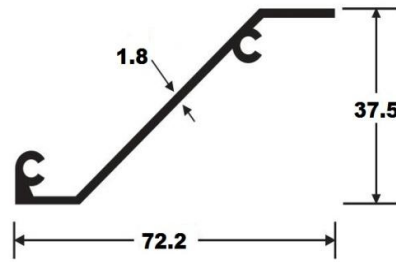

R.C-60002

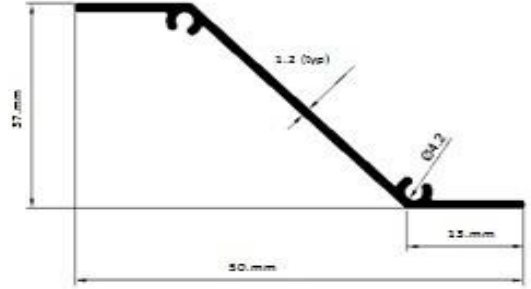

WT - 0.800 - 0.900 KG/ 12'

18X80 MATTING



R.C-61003

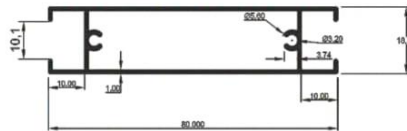

WEIGHT - 2.300 - 2.400 KG/12'

G SECTION



R.C-62001

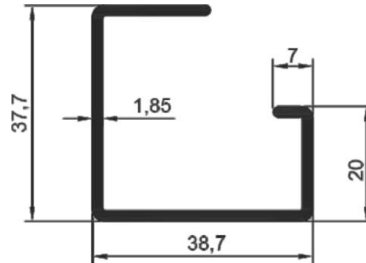

WEIGHT - 2.100 - 2.200 KG/12'

FLAT BAR

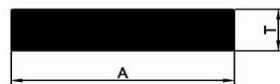

SEC. NO.	C/L	A	T	WT. RANGE
R.C-63001	12'	100	6	5.800 - 6.000
R.C-63002	12'	100	10	9.700 - 9.900
R.C-63003	12'	100	20	18.350 - 18.550
R.C-63004	12'	50	6	2.900 - 3.000
R.C-63005	12'	40	5	2.000 - 2.200

ANGLE



R.C. ALUMINIUM

AN ISO 9001-2015 CERTIFIED COMPANY

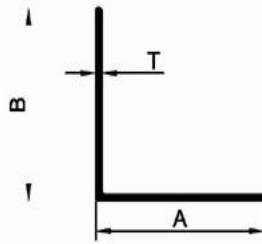

SEC. NO.	C/L	A	B	T	WT. RANGE
R.C-64001	12'	19	19	1.25	0.450 - 0.600
R.C-64002	12'	19	19	2.07	0.800 - 1.000
R.C-64003	12'	25	25	1	0.400 - 0.600
R.C-64004	12'	25	25	2	1.000 - 1.200
R.C-64005	12'	38	25	2.4	1.500 - 1.600
R.C-64005	12'	38	38	2.3	1.800 - 2.000

DOUBLE GLASS CHANNEL



R.C. ALUMINIUM

AN ISO 9001-2015 CERTIFIED COMPANY

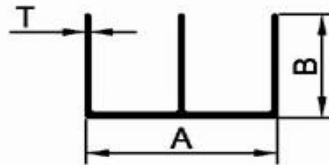

SEC. NO.	C/L	A	B	T	WT. RANGE
R.C-65001	12'	25	12	0.8	0.500 - 0.600
R.C-65002	12'	25	12	1.2	0.700 - 0.900
R.C-65003	12'	22	12	0.7	0.350 - 0.400
R.C-65004	12'	22	12	0.55	0.300 - 0.350

F CHANNEL



R.C. ALUMINIUM

AN ISO 9001-2015 CERTIFIED COMPANY

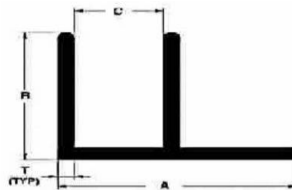

SE. NO.	C/L	A	B	T	WT. RANGE
R.C-66001	12'	21	16	1	0.400 - 0.500

Y CHANNEL



R.C. ALUMINIUM

AN ISO 9001-2015 CERTIFIED COMPANY



SE. NO.	C/L	A	B	T	WT. RANGE
R.C-67001	12'	33	12.7	0.8	0.400 - 0.500

BULB TEE



R.C. ALUMINIUM

AN ISO 9001-2015 CERTIFIED COMPANY

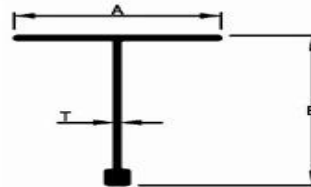

SEC. NO.	C/L	A	B	T	WT. RANGE
R.C-68001	12'	25	25	0.72	0.400 - 0.500
R.C-68002	12'	38	25	1	0.600 - 0.800

PLAIN TEE



R.C. ALUMINIUM

AN ISO 9001-2015 CERTIFIED COMPANY

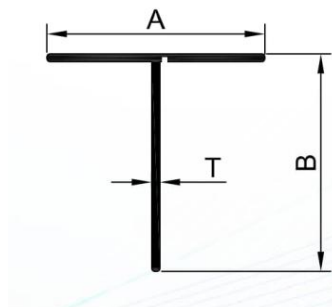

SEC. NO.	C/L	A	B	T	WT. RANGE
R.C-69001	12'	19	19	0.55	0.200 - 0.250
R.C-69002	12'	25	25	0.9	0.400 - .0450

GLAZING CLIP

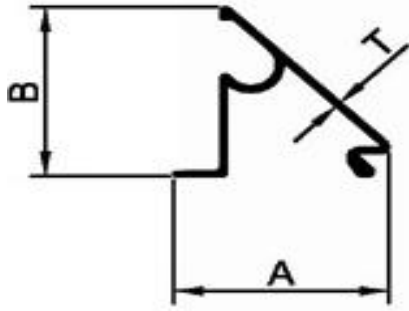

SEC. NO.	C/L	A	B	T	WT. RANGE
R.C-70001	12'	18.4	17	0.5	0.200 - 0.250
R.C-70002	12'	18.4	17	0.6	0.250 - 0.300

GLAZING PLATE

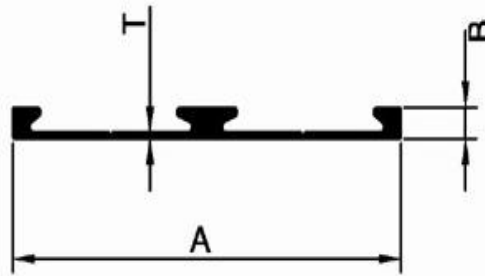

SEC. NO.	C/L	A	B	T	WT. RANGE
R.C-71001	12'	44.45	3	0.6	0.400 - 0.600

U CHANNLE

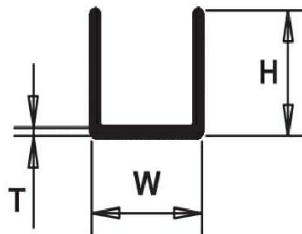

SEC. NO.	C/L	H	W	T	WT. RANGE
R.C-72001	12'	9	9	0.5	0.150 - 0.250
R.C-72002	12'	12	12	0.6	0.200 - 0.250

3X1 MOLDING HANDLE

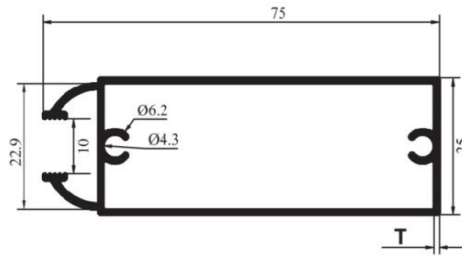

SEC. NO.	C/L	T	WT. RANGE
R.C-73001	12'	1	2.000 - 2.200

3X1 MOLDING MATTING

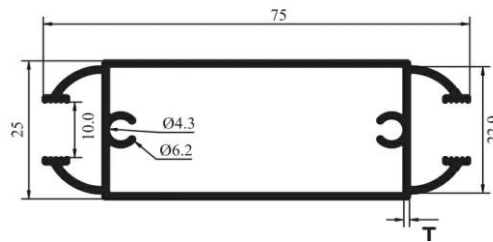

SEC. NO.	C/L	T	WT. RANGE
R.C-74001	12'	1	2.300 - 2.500

ZINGIN RAAD

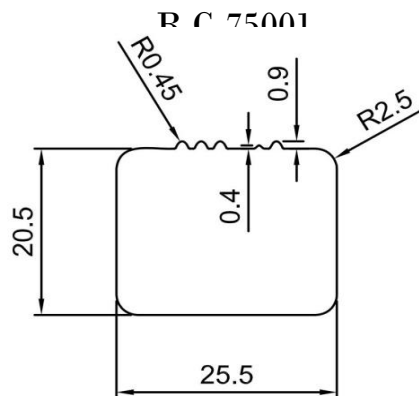

WT - 5.000 - 5.200 KG /12'

DOMAL 3 TRACK

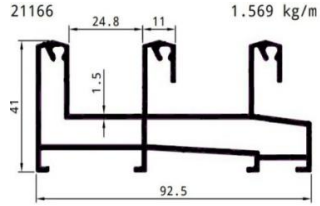

SEC. NO.	C/L	T	WT. RANGE
R.C-76001	12'	1.5	5.500 - 5.700

DOMAL SHUTTER (27MM)

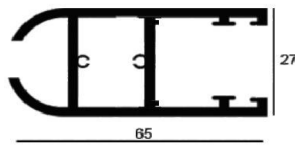

SEC. NO.	C/L	T	WT. RANGE
R.C-77001	12'	1.5	3.200 - 3.400

DOMAL CLIP (27MM)

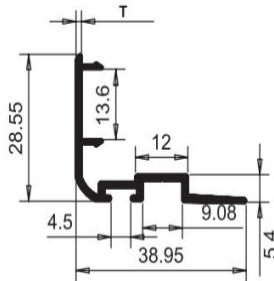

SEC. NO.	C/L	T	WT. RANGE
R.C-78001	12'	1.2	1.100 - 1.300

DOMAL 2 TRACK

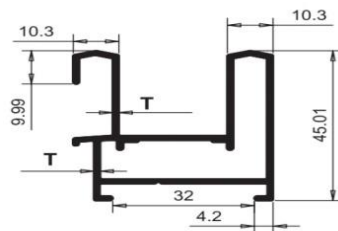

SEC. NO.	C/L	T	WT. RANGE
R.C-79001	12'	1.3	2.800 - 3.000

